

Demand More...

Yo-Yo WELLNESS app, will help you stand for **2-HOURS daily** as recommended by **Public Health England** to combat the health risks associated with prolonged and unbroken sedentary behaviour



YO-YO WELLNESS®
Keep Moving

Yo-Yo WELLNESS® height-adjustable desk range is equipped with SMART integrated software and control features designed to enhance mental & physical health, comfort, and overall well-being for users who spend extended periods working at their desks.

SMART Desk

Integrated technology to boost usage, track performance & improve health.



Integrated WELLNESS Technology

All desks in the Yo-Yo WELLNESS® range include complimentary SMART integrated software which connect to the Yo-Yo WELLNESS® App*:

- Empowers the user to set-up & save desk heights for sitting/standing
- To set goals and track performance (inc calorie burn)
- Set Timer prompts to remind you to “change position”

* Yo-Yo WELLNESS® software downloadable to PC (or Phone) from Microsoft, Android & Apple App Stores.

Nudges & Reminders

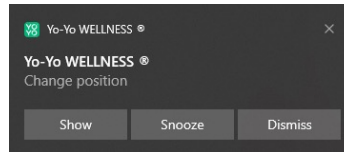
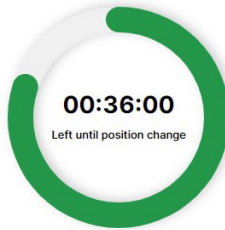

Manage Desk Heights

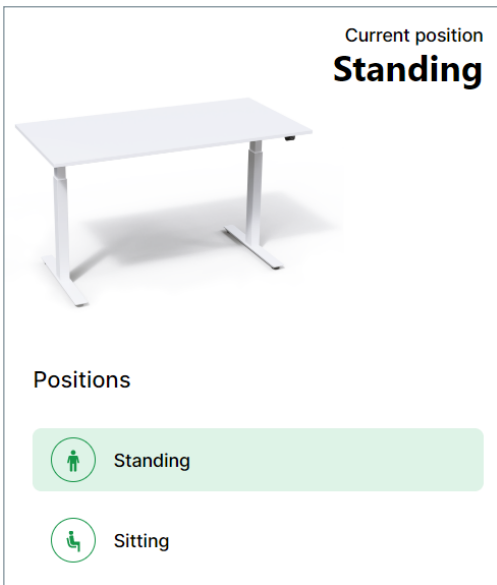

Set Goals

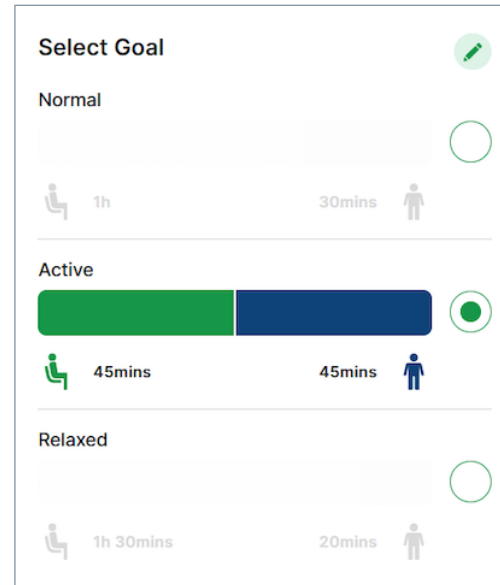

Tracking Performance

Daily and weekly analysis allows Yo-Yo WELLNESS® to empower the user to engage and monitor better practices with the aid of **statistics and graphs**:

- Sitting and Standing hours
- Position Changes each day
- Calorie burn
- Active time at desk

Weekly summary 25 Mar - 31 Mar

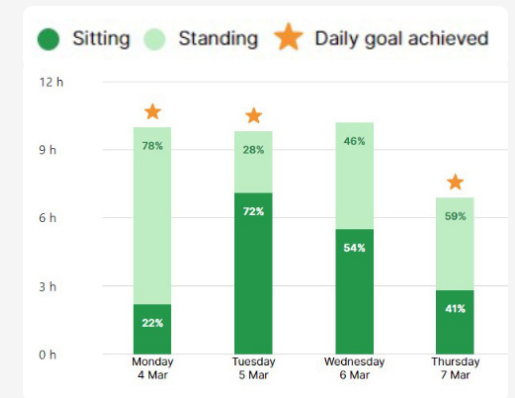
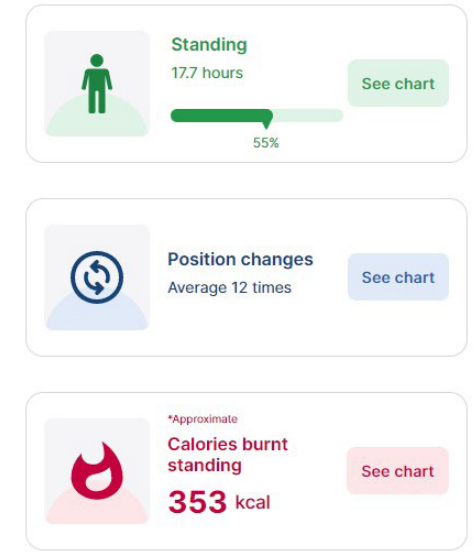

Yo-Yo WELLNESS® App





YO-YO WELLNESS[®]

UP&GO[™]

Next Day Delivery / 5-Minute Install

“SMART Desk” with unique focus on Wellness

Set-up & save a variety of features aimed at reducing sedentary behavior and minimising physical strain:

- Desk Heights for sitting/standing
- Goals for sitting/standing
- Timer Prompts
- Track performance

YO-YO WELLNESS®

EXEC 2+

Custom Design Options / 5-6 Week Delivery

“SMART Desk” with integrated Wellness Software

Integrated SMART sensors monitor desk usage, remind users to take breaks & provides feedback on ergonomics to promote better health and productivity.



YO-YO WELLNESS®

BACK 2 BACK Custom Design Options / 5-6 Week Delivery



“SMART Desk” with Data Analytics

User Analytics: monitor usage patterns, such as time spent sitting versus standing, calorie burn, position changes during each day.



SMART Desk: Sustainably Built



Integrated WELLNESS Technology

All desk models include complimentary SMART integrated software which connect to the Yo-Yo WELLNESS App, downloadable from both Microsoft, Android & Apple App Stores.



- Anti-Collision Technology
- Highest level of Environmental Certification



- Integrated Wellness Software
- Frame Colours: Black, White, Silver
- Bespoke RAL Frame Colour option
- 7-Year Warranty

Environmental Product Declarations



- ISO 14025
- ISO 14040
- ISO 14044
- ISO 21930
- EN 15804+A2

UP&GO™

NEXT Day Delivery & Quick Install



- Pre-Assembled / 5-Minute Install
- Height Range: 59 - 124 cm
- 100Kg Load capacity

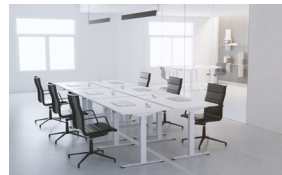

Single Box



Flexi Format

Custom Design Options / 5-6 Week Delivery

Customisable Options*

* 1 pallet MOQ

- **Leg Shape:** Rectangular, Square or Circular
- **Leg Direction:** Big UP or Big DOWN
- **Sidebar:** Fixed or Sliding Desktop
- **Bespoke RAL Frame colours** (7-8 weeks)

EXEC 2



- Height Range: 67 - 114 cm
- 120Kg Load capacity

EXEC 2+



- Height Range: 59 - 124 cm
- 120Kg Load capacity

EXEC 3+



- Height Range: 59 - 124 cm
- 180Kg Load capacity

BACK 2 BACK



- Height Range: 59 - 124 cm
- 120Kg Load capacity

MEETING



- Height Range: 59 - 124 cm
- 180Kg Load capacity

MONO



- Height Range: 67 - 114 cm
- 60Kg Load capacity
- Foot Base: Cross or H

Retrofit Flexibility

Custom Design Options / 5-6 Week Delivery

DESK SIT



- Fixed height. Non-adjustable
- Compatible leg & frame design



SITFLEX







- Fixed Height
- Incrementally Adjustable: 67 - 105 cm

Yo-Yo WELLNESS® desks are available in flexible design formats. There is a modest minimum order quantity of only ONE pallet with a lead time of 5-6 weeks.





Column Shape & Leg Format

<p>Rectangular Big / Down Big / Up</p> 	<p>Circular Big / Down Big / Up</p> 	<p>Square Big / Down</p> 
---	---	--

Foot Shape & Leg Position

<p>Flat Foot (A) Centered</p> 	<p>Flat Foot (A) Off-Centered</p> 
<p>Tapered Foot (B) Centered</p> 	<p>Tapered Foot (B) Off-Centered</p> 

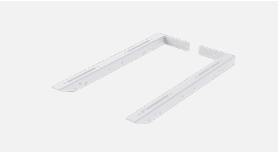
Sidebars & Privacy Screen Support

<p>Sidebar Universal</p> 	<p>Sliding Desktop</p> 	<p>Privacy Screen Support</p> 
<p>Sliding Desktop</p> 	<p>Off-Centered Feet</p> 	

Customisable options:

- Leg Shape:** Rectangular, Square or Circular
- Leg Direction:** Big UP or Big DOWN is a personal preference. Big UP provides marginally more stability at standing height but Big DOWN may look more elegant. You decide!
- Sidebars:** for Fixed or Sliding Desktops
- Feet Finish:** with Flat or Tapered edging

Bespoke RAL Frame colours 7-8 week lead time and minimum order of ONE pallet.



UP&GO®

Designed with "Ease of use" and sustainability in mind for office or home offices, **UP&GO®** is an elegant pre-assembled frame which can be built in 5-minutes. Available for NEXT DAY delivery.

 NEXT DAY delivery

 5-Min Install

Features

- Pre-Assembled, One box and Quick Install (5 minutes)
- Yo-Yo WELLNESS® software compatible

Specifications

Colours	Black, White, Silver
Motors	2 (3-Stage Telescopic Legs)
Load Capacity	100kg
Height Adjustment	59-124cm (Frame only)
Sustainability Certification	ISO 14025 ISO 14040 ISO 14044 ISO 21930 EN 527-2
Low standby consumption	0.02W
Anti-Collision Safety	Yes
MOQ / Origin / Lead time	1 unit / EU / Next Day
Warranty	7- Years



Single Box





EXEC 2

FLEXI Format

Our **standard height** sit-stand desk solution customisable with multiple **Flexi-Format** options. **EXEC 2** is suitable for both small and large office environments.



FLEXI Format



Customisable Options



Features

- **Flexi Format:** Leg shape, Leg Direction, Foot Design and Sidebars
- Yo-Yo WELLNESS® software compatible

Specifications

Colours	Black, White, Silver or BESPOKE
Motors	2 (2-Stage Telescopic Legs)
Load Capacity	120kg
Height Adjustment	67-114cm (Frame only)
Sustainability Certification	ISO 14025 ISO 14040 ISO 14044 ISO 21930 EN 527-2
Low standby consumption	0.02W
Anti-Collision Safety	Yes
MOQ / Origin / Lead time	20 units / EU / 5-6 weeks
Warranty	7- Years



EXEC 2+

FLEXI Format



Our **extra height** sit-stand desk solution customisable with multiple **Flexi-Format** options. **EXEC 2+** is suitable for both small and large office environments.



FLEXI Format



Customisable Options



Features

- **Flexi Format:** Leg shape, Leg Direction, Foot Design and Sidebars
- Yo-Yo WELLNESS® software compatible

Specifications

Colours	Black, White, Silver or BESPOKE
Motors	2 (3-Stage Telescopic Legs)
Load Capacity	120kg
Height Adjustment	59-124cm (Frame only)
Sustainability Certification	ISO 14025 ISO 14040 ISO 14044 ISO 21930 EN 527-2
Low standby consumption	0.02W
Anti-Collision Safety	Yes
MOQ / Origin / Lead time	20 units / EU / 5-6 weeks
Warranty	7- Years





EXEC 3+

FLEXI Format

Our **extra height corner** sit-stand desk solution customisable with multiple **Flexi-Format** options. **EXEC 3+** is suitable for both small and large office environments.



FLEXI Format



Customisable Options



Features

- **Flexi Format:** Leg shape, Leg Direction, Foot Design and Sidebars
- Yo-Yo WELLNESS® software compatible

Specifications

Colours	Black, White, Silver or BESPOKE
Motors	3 (3-Stage Telescopic Legs)
Load Capacity	180kg
Height Adjustment	59-124cm (Frame only)
Sustainability Certification	ISO 14025 ISO 14040 ISO 14044 ISO 21930 EN 527-2
Low standby consumption	0.02W
Anti-Collision Safety	Yes
MOQ / Origin / Lead time	12 units / EU / 5-6 weeks
Warranty	7- Years



BACK-2-BACK FLEXI Format



Duplex **extra height** sit-stand collaborative desking solution. Customisable with multiple **Flexi-Format** options. **BACK-2-BACK** is compatible with privacy and acoustic panels. The cable management options are adaptable.



FLEXI Format



Customisable Options



Features

- **Flexi Format:** Leg shape, Leg Direction, Foot Design and Sidebars
- Yo-Yo WELLNESS® software compatible

Specifications

Colours	Black, White, Silver or BESPOKE
Motors	2x2 (3-Stage Telescopic Legs)
Load Capacity	120kg
Height Adjustment	59-124cm (Frame only)
Sustainability Certification	ISO 14025 ISO 14040 ISO 14044 ISO 21930 EN 527-2
Low standby consumption	0.02W
Anti-Collision Safety	Yes
MOQ / Origin / Lead time	10 units / EU / 5-6 weeks
Warranty	7- Years

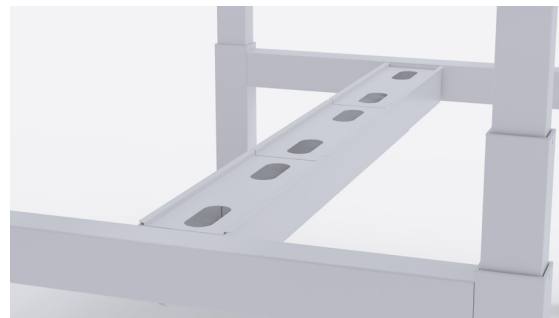



MEETING

FLEXI Format

Our **extra height** collaborative sit-stand conference desking solution customisable with multiple **Flexi-Format** options. Expandable Solution up to 8 legs. **MEETING** is built to highest standards of European certifications.



FLEXI Format



Customisable Options



Features

- **Flexi Format:** Leg shape, Leg Direction, Foot Design and Sidebars
- Yo-Yo WELLNESS® software compatible

Specifications

Colours	Black, White, Silver or BESPOKE
Motors	2 (3-Stage Telescopic Legs)
Load Capacity	120kg
Height Adjustment	59-124cm (Frame only)
Sustainability Certification	ISO 14025 ISO 14040 ISO 14044 ISO 21930 EN 527-2
Low standby consumption	0.02W
Anti-Collision Safety	Yes
MOQ / Origin / Lead time	12 units / EU / 5-6 weeks
Warranty	7- Years





DESIGN

Our **extra height** Swedish “Design thinking” sit-stand desk makes a statement in home and large office environments. **DESIGN** has been innovatively remodelled to give an unconventional expression with remarkable stability.

 Customisable Options



Features

- Yo-Yo WELLNESS® software compatible
- Made from 30% recycled steel

Specifications

Colours	Black, White, Silver or BESPOKE
Motors	2 (3-Stage Telescopic Legs)
Load Capacity	120kg
Height Adjustment	62-120cm (Frame only)
Sustainability Certification	ISO 14025 ISO 14040 ISO 14044 ISO 21930 EN 527-2
Low standby consumption	0.02W
Anti-Collision Safety	Yes
MOQ / Origin / Lead time	8 units / EU / 5-6 weeks
Warranty	7- Years





MONO

FLEXI Format

Our **standard height** sit-stand desking solution customisable with multiple **Flexi-Format** options. Highly stable **MONO** is suitable for both small and large office environments.



FLEXI Format



Customisable Options



Features

- **Flexi Format:** Leg shape, Leg Direction, Foot Design and Sidebars
- Yo-Yo WELLNESS® software compatible

Specifications

Colours	Black, White, Silver or BESPOKE
Motors	1 (2-Stage Telescopic Legs)
Load Capacity	60kg
Height Adjustment	67-114cm (Frame only)
Sustainability Certification	ISO 14025 ISO 14040 ISO 14044 ISO 21930 EN 527-2
Low standby consumption	0.02W
Anti-Collision Safety	Yes
MOQ / Origin / Lead time	10 units / EU / 5-6 weeks
Warranty	7- Years



YO-YO WELLNESS®

Keep Moving



Warren Fitzpatrick
Partnerships Director

M: +44 (0)7944 565 721
E: warren@yo-yooffice.co.uk



Ann Brennon
Account Manager

M: +44 (0)7901 275 573
E: ann@yo-yooffice.co.uk

Showroom:

Visit us @ 45 St.John Street, Clerkenwell, London, EC1M 4AN

Office:

Unit 1 Vulcan Court | Vulcan Way | Coalville | Leicestershire | LE67 3FW | UK